

MAXIMUM PCB SIZE

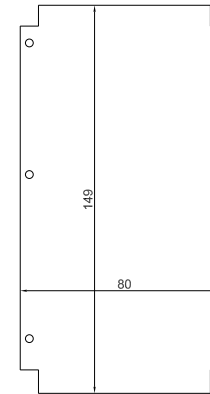

MINIMUM PCB SIZE

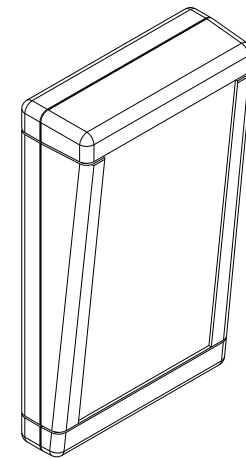
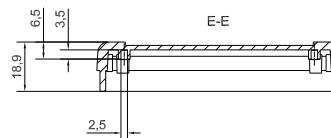
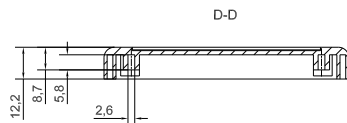
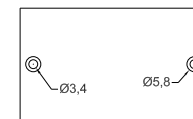
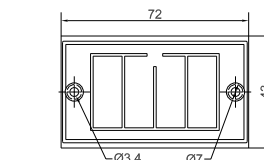
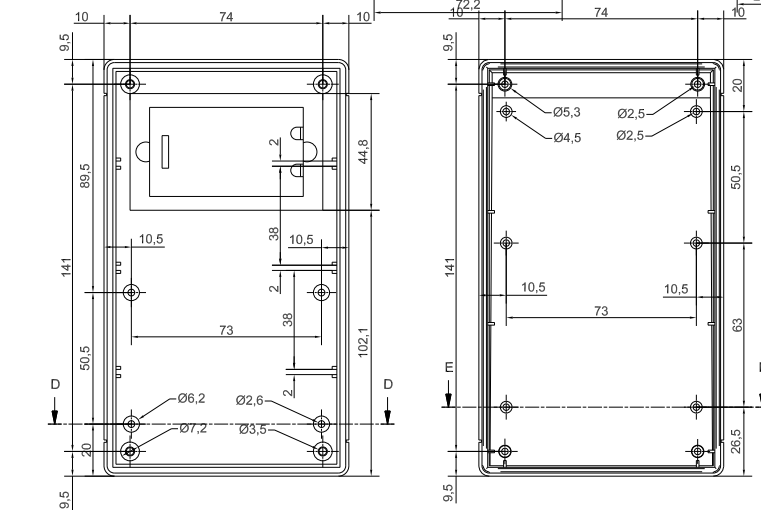
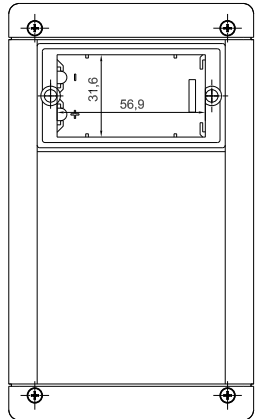
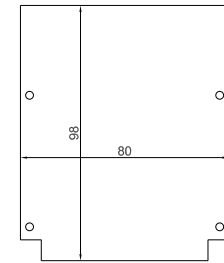

	Designation	Assembly TB-1SB	Part Number	TB-1SB
	Subject to technical modification without prior notice. Tipographical and other errors do not justify any claim for damages. All dimensions should be verified using an actual moulded part.			
	Rev. code	Size	Date	Project/Draw
	This document contains proprietary information of TEK® S.p.A. and is licensed subject to the conditions that the information be released in confidence, not be reproduced or copied and not be used or incorporated in any product.	18/05/2005	1:1	A1